

Current developments and examples of sustainable energy technologies



Sustainable Lighting

Research & development for new technologies and products from Austria



Today the lighting sector accounts for roughly 19 % of world electricity consumption, which corresponds to around 1,890 Mt of CO₂ emitted per year. Intelligent overall strategies, combining daylight with pioneering energy-efficient systems of artificial lighting, are capable of reducing electricity consumption and contributing significantly to diminishing global energy and resource consumption.



Office lighting with LEDs i+R Gruppe Lauterach, Photo: Zumtobel

New technologies for energy-efficient lighting systems

The lighting sector is currently undergoing massive change. Around the world research institutes and commercial firms are working on developing new technologies and products for sustainable, energy-saving lighting systems.

Within a few years classical filament bulbs will have disappeared from daily life. The reason is the EU Commission's step-by-step ban on inefficient sources of light. In Europe replacing filament bulbs with compact fluorescent lamps (CFLs) was seen as the way forward for a long time. However, CFLs have disadvantages; for instance, they do not provide light instantly when switched on, and disposal is difficult because they contain mercury, a poison.

LED technology is a pioneering alternative. Light-emitting diodes (LEDs) have improved dramatically in efficiency and light output in recent years, and could well displace conventional lighting systems in many fields in the future. They are robust, have a long service life and score well on quality of light and colour rendering, which makes them increasingly attractive for general-purpose lighting. LEDs respond quickly when switched on, are easy to dim, and can be regulated dynamically.

The technology's great potential is revealed by the fact that in 2014 the Nobel Prize for Physics was awarded to three LED researchers: Isamu Akasaki and Hiroshi Amano (Japan) and Shuji

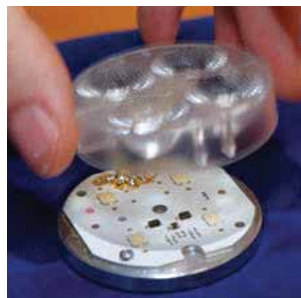
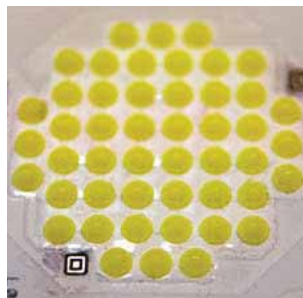

Tridonic modules P350 (on left) and Fulmen (on right), both photos: Hans Ringhofer

Nakamura (USA), who achieved a breakthrough with the semiconductor material gallium nitride in the 1990s for developing LED lamps for general-purpose lighting.

LED – a technology with real potential

Demand for this technology is growing apace; according to the consultancy firm McKinsey, the global LED market will grow by a factor of seven up to 2020, to a volume of 65 billion Euro. The Austrian Energy Agency also sees LED technology as a fully-developed alternative to conventional filament bulbs. LEDs' forecast share of the European lighting market in 2020 is as follows:

- > restaurants and hotels 80 %
- > architectural lighting 80 %
- > shop lighting 65 %
- > outdoor lighting 60 %
- > office lighting 37 %
- > plant lighting 20 %

(Source: Austrian Energy Agency)

In close collaboration with scientific and research institutions the Austrian lighting industry has been developing new products and technologies for energy-efficient lighting systems for some years. Austrian research activities in this field take place within international networks, e.g. via the Austrian Federal Ministry for Transport, Innovation and Technology, in the context of the activities of the International Energy Agency (IEA-EBC Annex 45: Energy-Efficient Electric Lighting for Buildings).

With support of the funding programs of the Climate & Energy Fund and the Federal Ministry for Transport, Innovation and Technology Austrian firms are continually developing pioneering technologies and products to commercial viability. Below some of these innovative projects are presented. ■

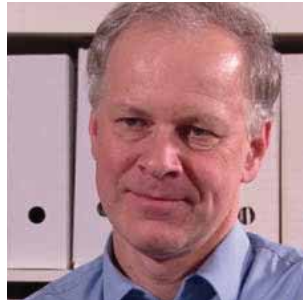

Paul Hartmann,
JOANNEUM RESEARCH
ForschungsgmbH
on the development
of LED technology

In the long term LEDs have the potential to take the place of conventional lighting systems on a large scale. What do you consider to be the greatest advantages of this technology?

Today LEDs are already the most efficient of all sources of white light. Their advantages over compact fluorescent lamps are freedom from mercury and a better light spectrum. LED lights have a long service life and can be regulated. With complex LED systems it is possible not only to dim light intensity but also to set up different overall colours; that makes this technology so interesting for all sorts of forthcoming applications.

Why are LED systems so energy-efficient?

Filament bulbs radiate a good deal of heat, whereas LEDs radiate very little; because their emission spectrum is concentrated on visible light wavelengths, they achieve a very high level of energy efficiency. On the other hand, semiconductor technology itself has grown more and more efficient in recent years.

Will the new developments soon make low-cost solutions for the mass market possible?

I'm convinced of that. As production volumes increase, the cost of production – and thus sales prices – will continue to drop. If you look at the total cost of ownership, i.e. the sum of purchase price plus the cost of the energy consumed, LED lamps are already extremely competitive even today.

How does Austrian research and development shape up in international competition?

University and non-university research here is certainly respected internationally, and then a great deal of research in the lighting sector is in progress in Austrian industry; for instance, in the field of chip-on-board technology Tridonic are in the lead. We have any number of pioneering, successful lamp manufacturers, from large firms such as Zumtobel, via medium-sized companies like XAL, to small firms like Lumitech or EcoCan that can provide very interesting innovations in the LED field. To ensure Austria's prospects here, though, we must invest massively in new areas of research in future, too.

Where is more research needed?

Production must be made more efficient, so that we can get low-cost solutions to the market. It's also important to improve the quality of white light. In future, completely new sources of light, such as laser devices, could become marketable – here too there is a tremendous need for research. From the point of view of sustainability, biogenic approaches, such as utilizing bioluminescence for lighting, would be an interesting area for research.

LED technology

How it works and what it can lead to

Whereas in conventional lamps light is emitted by a filament or a gas, LEDs are tiny electronic chips made from special-purpose semiconductor material. If electricity flows through the chip it starts to emit light (a process known as electroluminescence). LEDs act very nearly as a point source of light, without radiating heat.

These diodes can emit only single-coloured light, which must then be converted into white light. The currently most satisfactory method uses the principle of colour conversion by luminescence: in this case an ultra-thin layer of yellow phosphorus, brought up over a blue LED chip, converts some of the blue light into white light. A second way of obtaining white light from LEDs is to mix coloured light of differing wavelengths.

LED modules have an extremely long service life (more than 50,000 hours of operation) and are remarkably energy-efficient. LEDs deliver the same amount of light (measured in lumen) as conventional lamps, but consume much less electricity. For instance, a 60-watt bulb delivers about 600 lumen, while an LED lamp needs a mere 8 watts to deliver 600 lumen. ■

TECHNOLOGY

As the starting-point for LEDs, semiconductor crystals are grown on a substrate and then sliced into chips. The diodes feature a negatively conducting base semiconductor with an electron surplus. An ultra-thin positively conducting semiconductor layer with "holes", i.e. a shortage of electrons, is deposited on this base. When a voltage is applied, the surplus electrons and the holes recombine in the so-called depletion layer of the semiconductor crystal, releasing energy in form of light.

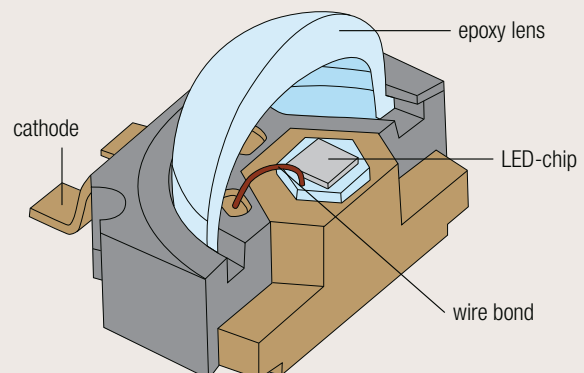

Source: Licht.de

Future LED Bulb

Energy-saving replacement for filament bulbs, aimed at the mass market

2007 Infineon Technologies Austria AG launched an ambitious R&D program in collaboration with Zumtobel Lighting GmbH and Tridonic Jennersdorf GmbH, aiming to develop new energy-efficient LED lamps to satisfy the most demanding customers, as suitable replacements for conventional filament bulbs in the mass market.

The flagship project “Future LED Bulb” was aimed at developing LEDs with the following characteristics:

- > top energy efficiency
- > constant, pleasant colour temperature
- > constant intensity
- > extremely long service life (approx. 50,000 hours)
- > attractive market price
- > capacity for dimming by means of existing systems

In the course of the project new lamps with an exceptionally long service life were developed; they are equipped with extremely efficient ultra-compact DC converters and low-loss LED drivers with new control algorithms to set colour temperature and stabilize the luminous flux. Further challenges involved attractive design, suitable distribution of light and ensuring that no system components overheat. Heat flow management, the new mechanical design, the LED optics and the power-supply electronics were additional research issues calling for considerable innovation.

As development progressed, the limits of heat flow management at that time were revealed. To implement a compact LED-based alternative to filament bulbs with more than 1000 lumen (roughly equivalent to the luminous flux from a 75-watt bulb), for instance, it was necessary to incorporate an exceptionally quiet active cool-



Future LED Bulb, Source: LEDON

ing device. This pioneering approach makes it possible to manage the heat flow of LEDs with 2000 lumen and more in miniaturized formats. In response to the EU’s phasing filament bulbs out, the project partners quickly started deriving marketable products from their research. In 2009 Zumtobel launched a subsidiary, LEDON, to exploit the new developments. Both the luminous flux of the “LED bulb” and the efficiency of the pioneering switching approach still lead the field internationally. With a colour rendering index $Ra \geq 90$, the product in question sets a benchmark in the market for alternatives to filament bulbs.

Meanwhile Infineon brought out the ICL8001G LED driver and the corresponding demoboard. With the aid of the upstream control setup developed in the project, the number of components required was reduced from more than 50 to roughly 30. Today the Infineon range in the lighting sector is largely made up of products for LED systems.

A key area of future research will be how to incorporate LEDs into new approaches to energy-efficient office and industrial lighting. As part of the project suitable features have already been developed, to make integration in intelligent, sustainable energy systems feasible. Individually switchable LED lamps fit into daylight dimming systems very well. With the aid of high-tech sensors the shortfall of daylight is computed and the level of artificial lighting matched to current needs; in this way electricity consumption can be reduced by up to 60 %. ■

„In LED technology Infineon can take full advantage of their local R&D competence as regards energy-efficient power semiconductors. Intelligent electronics using know-how from Infineon Austria results in ecologically sound LED lighting in homes, in professional lighting and in road vehicles. As ever smaller, ever more energy-efficient chips are developed, using pioneering, sustainable LED lighting solutions becomes increasingly attractive, and their share of the entire lighting market will grow significantly in the next few years.”

*Sabine Herlitschka,
Chair of Board and CTO, Infineon Technologies Austria AG*



Photo: Infineon



LED office lighting at Illwerke Montafon, Photo: Zumtobel

LED Office Dynamic LED lighting for better workplaces

A large number of studies have demonstrated that workplace lighting has a considerable influence on people's productivity and well-being. The Austrian lighting specialists Zumtobel Lighting GmbH and LUMITECH Produktion und Entwicklung GmbH have been researching this issue for years now, and are continually developing pioneering products and strategies for office applications. For instance, in collaboration with the Fraunhofer Institut Zumtobel has initiated a global study of users aimed at assessing the perceived quality of lighting in offices.

In 2010, when the BEWAG Netz GmbH office building was renovated, a comprehensive approach to cutting-edge, energy-efficient lighting in offices was demonstrated in a pilot project. The approach chosen was to light each of around 85 workplaces with a Light Fields floor lamp delivering an amount of light varying with the time of day. For this Zumtobel floor lamps were equipped with an LED technology (PI-LED®) which achieves excellent colour rendering. The integrated control device makes it possible to obtain light with differing colour temperatures (in the range 2700 to 6500 K) individually.

Whereas conventional fluorescent lamps scatter indirect light throughout the space in a pleasantly diffuse way, light from LED lamps is directed straight at the desk with no scatter or dazzle at all. The amount of light provided is regulated to follow the pattern of natural daylight; this is intended to improve well-being and productivity at the workplace.

Another advantage: with energy-efficient LED lighting electricity and expense are saved. With intelligent light control expenditure on electricity and maintenance can be lowered even further. The lighting in the offices is regulated automatically, and is switched on only where it is actually needed. To do this, all offices and corridors are equipped with occupancy sensors. On sunny days the lighting in corridors and stairways often stays off the whole day, as enough daylight gets in. ▣



Office lighting with LEDs, Photos: Energie Burgenland AG

ADLED

Advanced LED Modules and Light-Engines for Professional Lighting

The aim of this R&D project was to develop pioneering technologies for LED lighting systems on the basis of completely new PCB (Printed Circuit Board) engineering, so as to maximize the energy efficiency and light output of LED modules and LED light engines while improving heat flow management. The resulting developments are to be put to work at reasonable cost in various professional lighting products, where they should yield significant energy savings.



On the basis of these research activities Tridonic Jennersdorf GmbH launched the LED module TALEXX engine STARK SLE as a sustainable system solution for LED downlights and spotlights; this product is remarkably efficient (156 lumen/watt) and achieves a service life of 50,000 hours with a decline in luminous flux of at most 10 %. Over 960,000 LED-modules have been produced so far with substrates developed in the ADLED-project.

During this project research organizations and commercial firms in the fields of PCB technology and LED module fabrication collaborated closely. Tridonic Jennersdorf GmbH, AT & S AG, the Institute of Sensor and Actuator Systems at Vienna University of Technology and the Institute for Surface Technologies and Photonics at JOANNEUM RESEARCH Forschungsgesellschaft mbH contributed their particular expertise as regards heat flow management, PCB fabrication, integrated circuit packaging, LED module production and optical system integration.

The project yielded entirely new approaches to integrating all the necessary components functionally, from innovative PCB and packaging technologies to improving the amount of light released and quality of light from LED modules. Promising PCB designs with excellent heat dispersion and high surface light reflection were successfully implemented in two prototypes.

To simplify installing a reflector, an integrated coupling mechanism suitable for a large number of standard reflectors makes exact positioning easy. In addition, a specially compact version (active light-emitting area with diameter 13 mm) has been developed, to fit in with the trend in high-contrast shop lighting toward releasing light through smaller areas. In fabricating the LED module time and material are saved, since the thermal interface is a permanent part of the module and does not need applying to the heat sink in the form of paste or foil, as it normally would.

The LED module is suitable for a wide range of commercial applications (e.g. product illumination in shops, etc.). The statically white SLE is available with a colour rendering index (CRI) of > 80 (Classic) or > 90 (SELECT). For lighting applications in the field of culture and the arts a special module with new full-spectrum technology and a CRI of 98 has been developed. ■

„LEDs are in process of displacing conventional luminaires across the board. This has been made possible by the gains in efficiency achieved in recent years. Projects like ADLED help us to maintain our technological lead in close collaboration with our partners.”



Photo Tridonic Jennersdorf

Steffen Riemer,
Management of Tridonic Jennersdorf GmbH



*SLE module with housing (above) and without (below),
Photos: Tridonic Jennersdorf GmbH*

SIRIUS

Intelligent management system for energy-saving street lighting

Photo: Swarco Futurit

Lighting roads and car parks consumes a great deal of electricity. This can be reduced significantly with the aid of modern LED lighting. Current developments in the field of outdoor lighting are aimed at improving energy efficiency even more by means of intelligent management.

With the Futurlux 2011 LED street lamp SWARCO Futurit have launched a product capable of achieving energy savings of up to 80 % vis-à-vis conventional types of street lamps, such as sodium-vapour, mercury-vapour or halogen lamps. In the SIRIUS project an integrated approach is now being implemented, to make it possible to provide "light as required" within the framework of a higher-level traffic management system. Sensors and a communications network are employed to adjust the brightness of the street lighting to actual traffic levels and thus save electricity.

In partnership with the Institute of Computer Technology at Vienna University of Technology, the municipal electricity company in Wels and the firm of Energy Changes, sensor-based services and maintenance services have been developed and implemented as software in a lighting management system. The sensor-based services use data from traffic sensors installed on

site (as recorded in a traffic management system) as input. Data for the maintenance services come from the street lamps, which are equipped with a smart control and communication module. Data are exchanged between the systems via open, standardized interfaces. Commands such as "On/Off" or "Alter brightness" are transmitted to the lamps by wireless communication.

As a test, the system is currently running in three Austrian facilities, in Neunkirchen, Waidhofen/Thaya and Krems; the main focus is on regulating the lighting in line with traffic levels, i.e. the actual traffic situation is detected and a brightness setpoint is derived from it in the shape of an energy profile, by means of defined parameters.

Assessment reveals that, depending on volumes of traffic, savings of between 30 % and 50 % can be achieved on site. In the follow-on project Sirius+ the team is exploring further areas of application and ways to tie in data from other sensor systems. ■

Graphic: Swarco Futurit

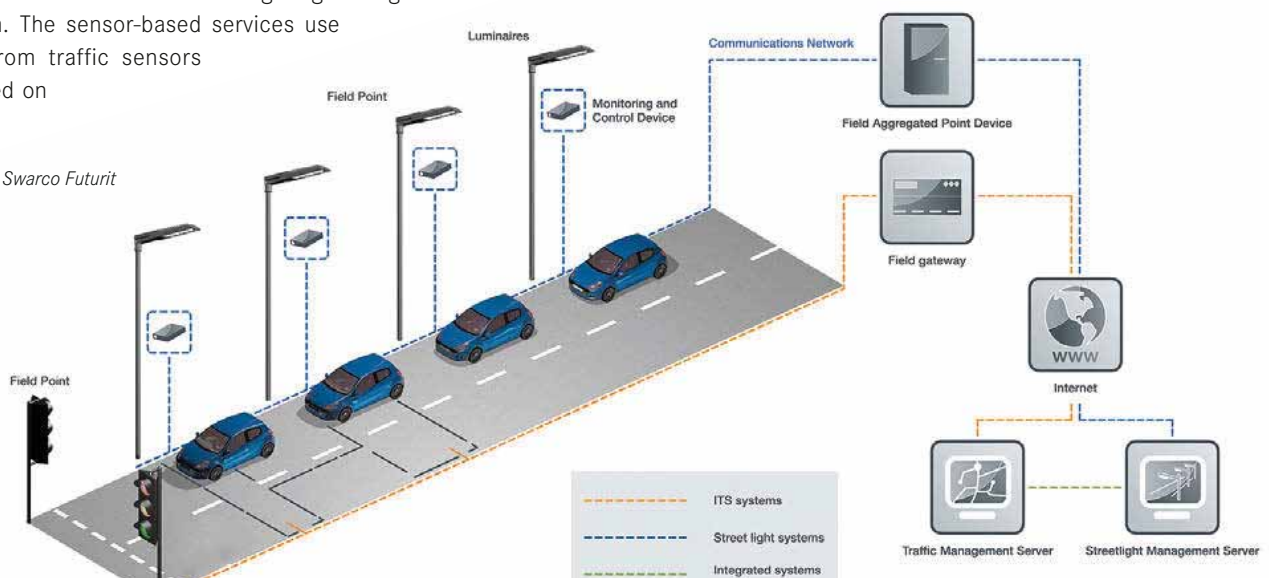

Organic LEDs Research for greater efficiency and light output

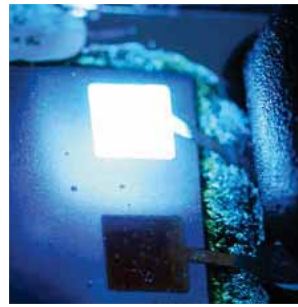

Photos: NanoTecCenter Weiz

An organic light-emitting diode (OLED) contains a thin-film electroluminescent component (of organic semiconducting material). OLEDs combine the electrical properties of classical semiconductors with the mechanical properties of plastics, and are of interest for a wide range of display and lighting applications. As OLEDs are flexible and extremely thin, this technology opens up any number of possible designs for flat or flexible devices. And as no crystalline materials are needed to fabricate OLEDs, low-cost production is feasible.

A few applications have already achieved commercial viability; however, today's OLEDs are a long way off their peak performance as regards efficient use of electricity and light output. Photonic research concentrates on generating white light with OLEDs in an energy-efficient way. The NanoTecCenter in Weiz is currently researching plasmon structures in collaboration with the Karl-Franzens University in Graz, and testing what positive effects they have on the coupling-out of the OLEDs emitting white light.

Here the aim is to develop a plasmon-amplified OLED with a broad spectrum of emission, and to increase light output by 30 %. OLED technology is based on a light-emitting organic layer located between a metal cathode and a transparent anode on a transparent substrate.

One of the challenges is to increase the share of the emitted light that leaves the substrate. As things stand roughly 50 % of the photons are absorbed by the multi-layer stack or reflected within the transparent substrate, and are thus wasted. To assess how efficiently light is released, a wave optical approach is helpful. To make use of the light retained inside the component, the researchers are trying to minimize wastage within the OLED stack by incorporating plasmon structures in it, as a way of releasing more light. ■

energy innovation austria presents current Austrian developments and results from research work in the field of forward-looking energy technologies. The content is based on research projects funded by the Austrian Federal Ministry for Transport, Innovation and Technology and the Climate and Energy Fund.

www.nachhaltigwirtschaften.at www.klimafonds.gv.at

INFORMATION

Future LED Bulb

Infineon Technologies Austria AG
Contact: Herbert Pairitsch
herbert.pairitsch@infineon.com
www.infineon.com/austria

LED Office

ZG Lighting Austria GmbH
Contact: Christoph Henke
christop.henke@zumtobelgroup.com
www.zumtobel.com

ADLED

Tridonic Jennersdorf GmbH
Contact: Franz Schrank
franz.schrank@tridonic.com
www.tridonic.com

SIRIUS

Swarco Futurit Verkehrssignalsysteme Ges.m.b.H.
Contact: Thomas Novak
novak.futurit@swarco.com
www.swarcofuturit.com

OLED Increase of light output

NanoTecCenter Weiz Forschungsgesellschaft mbH
Contact: Manuel Auer
Manuel.Auer@ntc-weiz.at
www.ntc-weiz.at

Research LED-Technology

Joanneum Research Forschungsgesellschaft.m.b.H.
Institute for Surface Technologies and Photonics
Contact: Paul Hartmann
paul.hartmann@joanneum.at
www.joanneum.at

IMPRINT

Published by Austrian Federal Ministry for Transport, Innovation and Technology, (Radetzkystraße 2, 1030 Vienna, Austria) in cooperation with the Climate and Energy Fund (Gumpendorferstr. 5/22, 1060 Vienna, Austria)

Edited and designed by Projektfabrik Waldhör KG, 1010 Vienna, Am Hof 13/7, www.projektfabrik.at

For change of your shipping address contact: versand@projektfabrik.at